

MAGELLAN DESIGNS

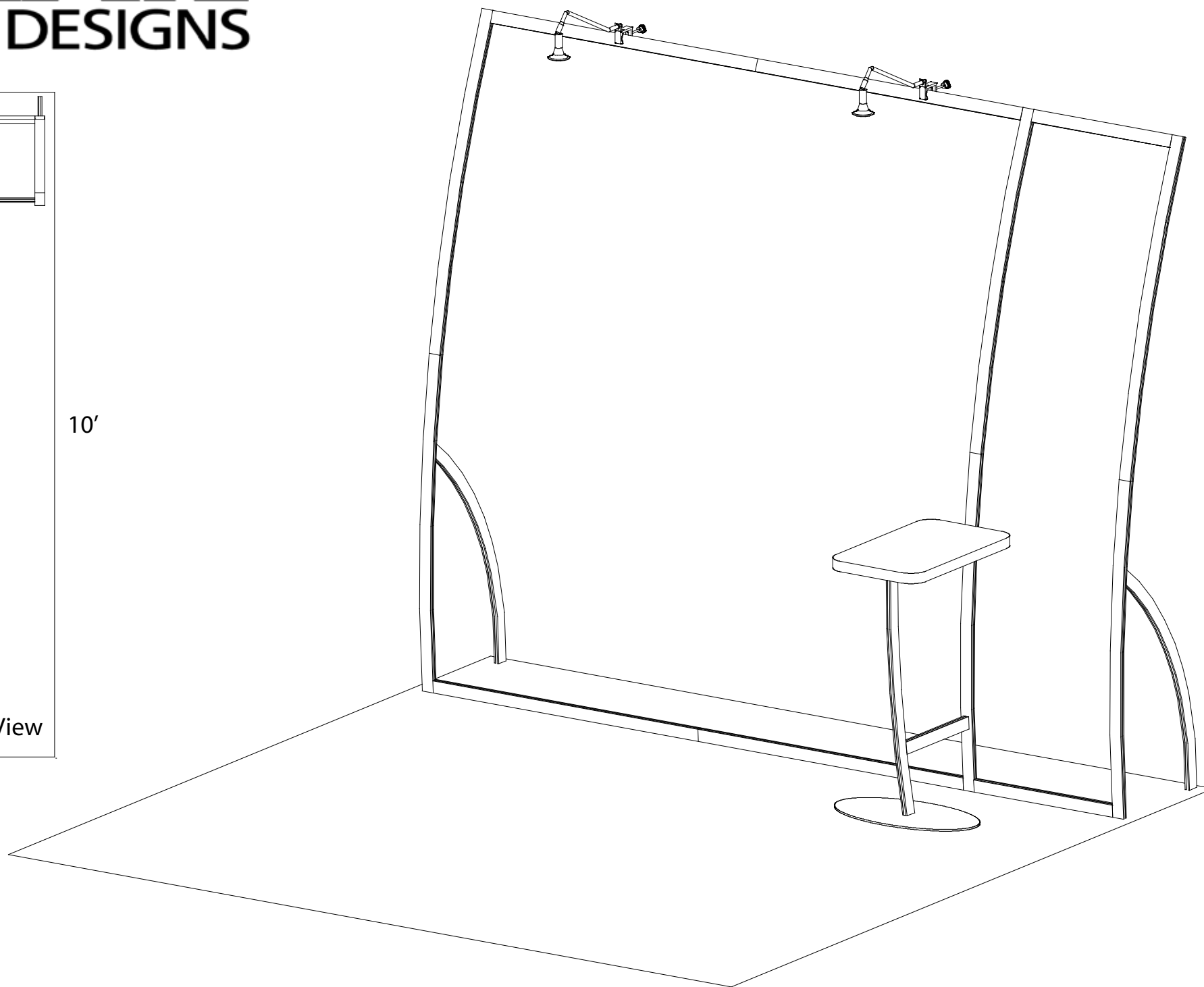
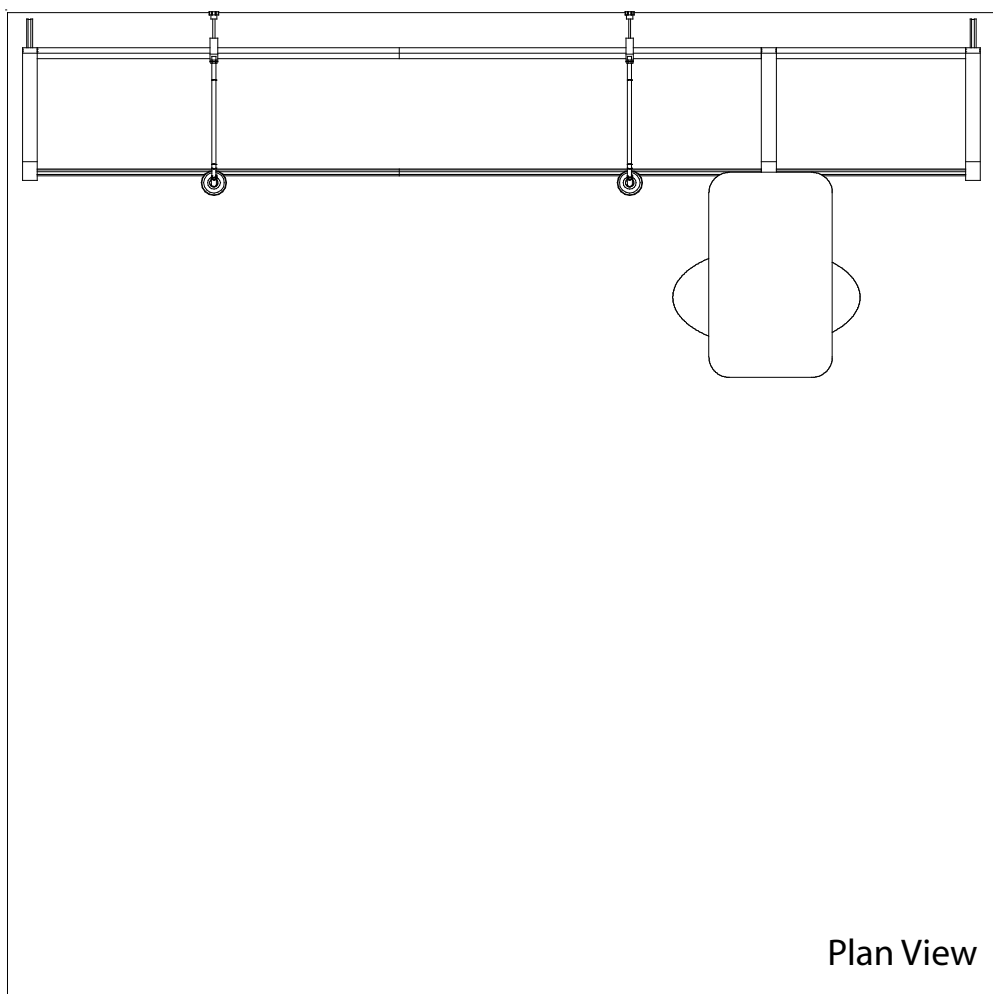

WHEN DISASSEMBLING ALUMINUM EXTRUSION, TIGHTEN ALL SETSCREWS AND LOCKS TO PREVENT LOSS DURING SHIPPING

MAGELLAN DESIGNS

Using Your Set-up Instructions:

The Visionary Designs Set-up Instructions for Magellan displays are created specifically for your configuration. They are laid out sequentially, including an exploded view of the entire display and a logical series of detailed steps for assembly. We encourage you to study the instructions **before** attempting to assemble your exhibit.

THIS IS VERY IMPORTANT!

Each page reminds you to tighten the setscrews after disassembling your exhibit to prevent loss of the locks and setscrews (see below in red).

Cleaning & Packing Your Display:

- 1) Use care when cleaning aluminum extrusions or acrylic inserts. Use only non-abrasive cleaners.
- 2) When cleaning laminate inserts or counter tops, use mild cleansers and a soft material such as cotton.
- 3) Keep all display components away from extreme heat and long exposure to sunlight to avoid warping and fading.
- 4) Retain all packing materials. It will make re-packing much easier and will reduce the likelihood of shipping damage.

Hex Key Tool



Most visionary design exhibits can be assembled with the supplied Hex Key Tool. Occasionally, a flat head screwdriver may be required.

Typical Connection



Detail A: Most horizontal extrusion connections have a patented expandable lock. This lock inserts into the groove of an opposing extrusion. Tightening the lock with the Hex Key Tool expands the lock and creates a strong positive connection.

Typical Connection



Numbered Label

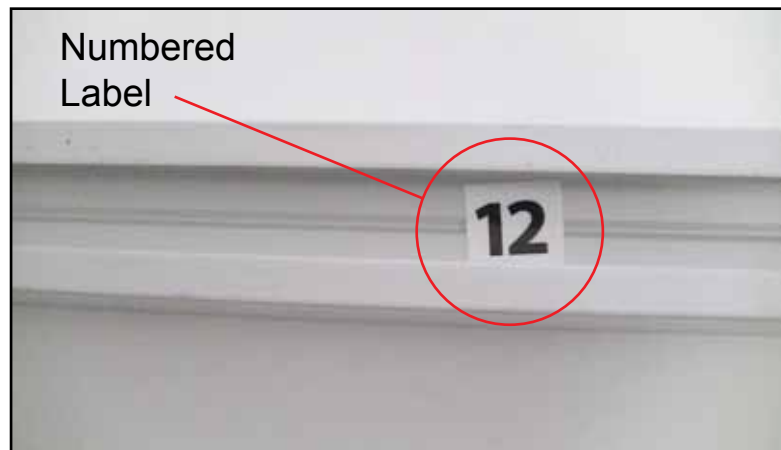

Detail B: Each extrusion contains a numbered label that corresponds to set-up instructions. The label is located within a groove of the extrusion (when possible). Visionary Design labels contain Black numbers unless otherwise specified.

Horizontal Connection

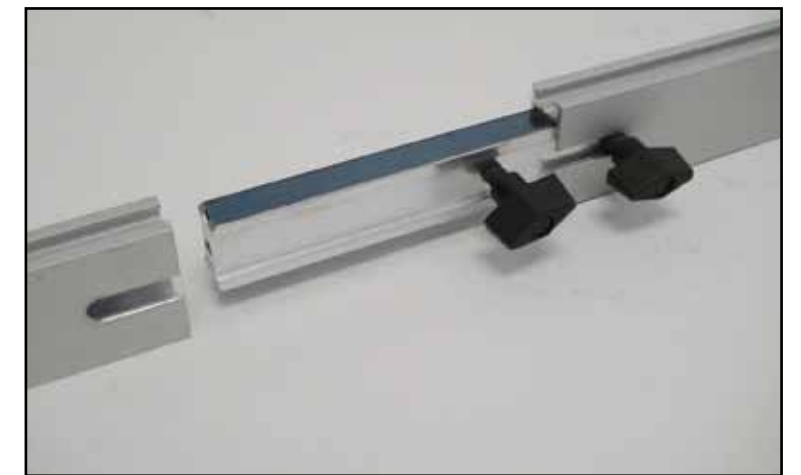

Detail C: A rectangular connection bar with plastic T Knobs is inserted between two horizontal extrusions joined end-to-end. Turn the knobs clockwise to tighten. Do Not Overtighten.

WHEN DISASSEMBLING ALUMINUM EXTRUSION, TIGHTEN ALL SETSCREWS AND LOCKS TO PREVENT LOSS DURING SHIPPING

866.652.2100

Part #	Qty	Description
1	1	48.5" h Lower Curved Extrusion
2	1	48.5" h Upper Curved Extrusion
3	1	48.5" h Lower Curved Extrusion
4	1	48.5" h Upper Curved Extrusion
5	1	48.5" h Lower Curved Extrusion
6	1	48.5" h Upper Curved Extrusion
7a/7b	1/1	44" w Lower Horizontal Extrusion
8a/8b	1/1	44" w Upper Horizontal Extrusion
9	1	23" w Lower Horizontal Extrusion
10	1	23" w Upper Horizontal Extrusion
11	1	Backwall Support Leg Extrusion
12	1	Backwall Support Leg Extrusion

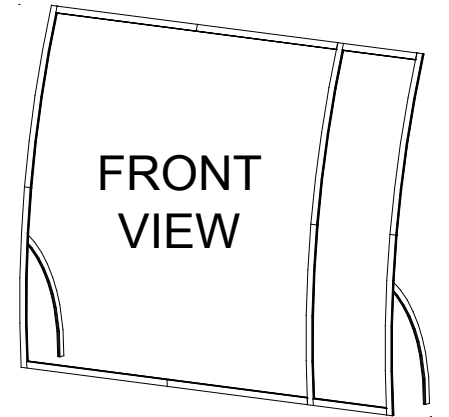
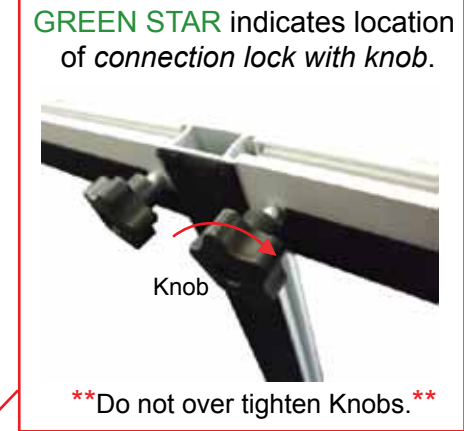
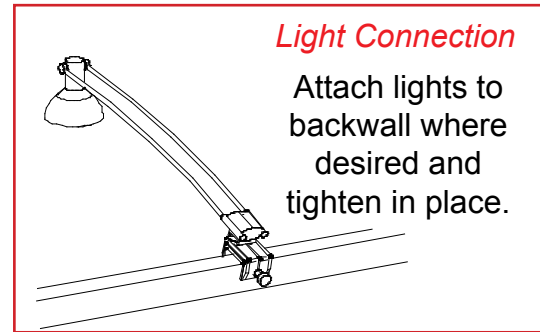

Steps

Unit can be assembled face down on the floor then lifted upright.

- 1) Connect backwall upper and lower verticals together [1 to 2, 3 to 4 and 5 to 6].
- 2) Connect horizontal extrusions together [7a to 7b and 8a to 8b].
- 3) Attach horizontal assemblies [7a/7b and 8a/8b] between vertical assemblies [1/2 and 3/4].
- 4) Attach horizontal extrusions [9 and 10] between vertical assemblies [3/4 and 5/6].
- 5) Attach support leg extrusions [11 and 12] to back of verticals [1 and 5], see leg attachment detail.

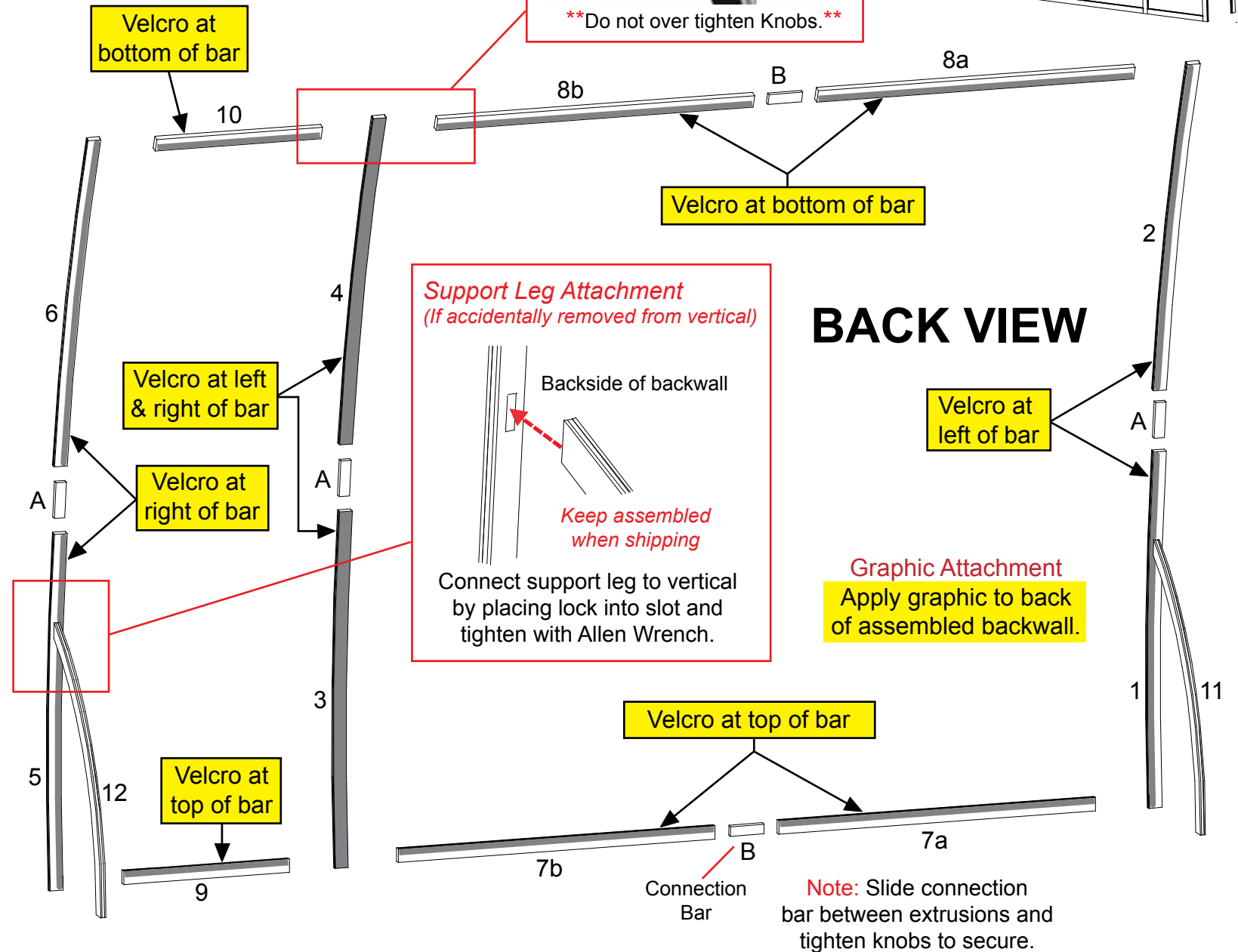

Rear View of Display

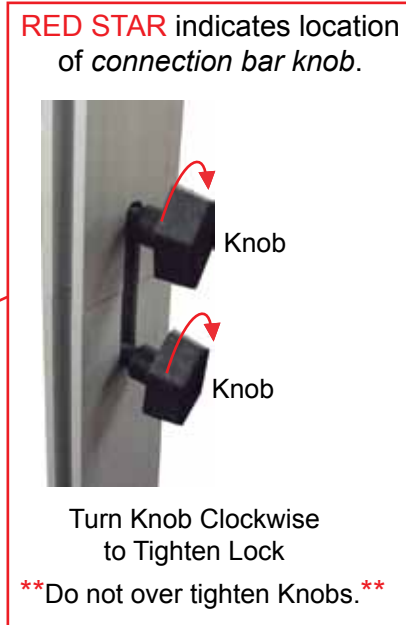
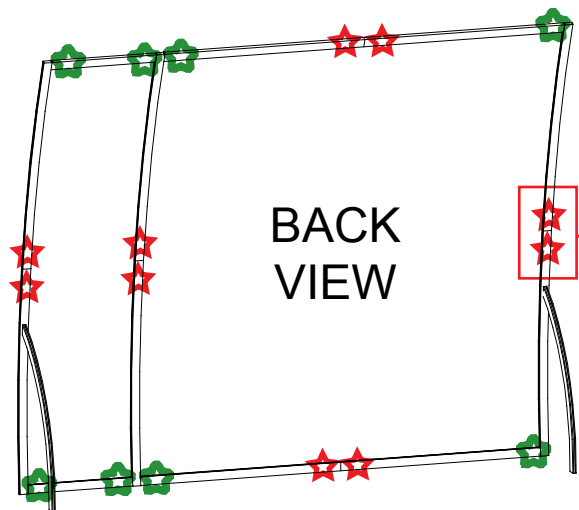

WHEN DISASSEMBLING ALUMINUM EXTRUSION, TIGHTEN ALL SETSCREWS AND LOCKS TO PREVENT LOSS DURING SHIPPING

866.652.2100

Part Number	Qty	Description
13	1	Base Plate
14	1	37.6" h Curved Vertical Extrusion
14a	1	Oval Flange Plate
15	1	18.5" w Horizontal Extrusion
16	1	15.69" w Horizontal Extrusion

Steps

- 1) Attach curved vertical [14] to base plate [13], see Base Plate Attachment detail.
- 2) Attach horizontal extrusions [15 and 16] between curved vertical [14] and backwall vertical [3] where indicated.
- 3) Attach flange plate to top of vertical [14] as shown.
- 4) Place counter top on assembled counter base, see Counter Attachment detail.

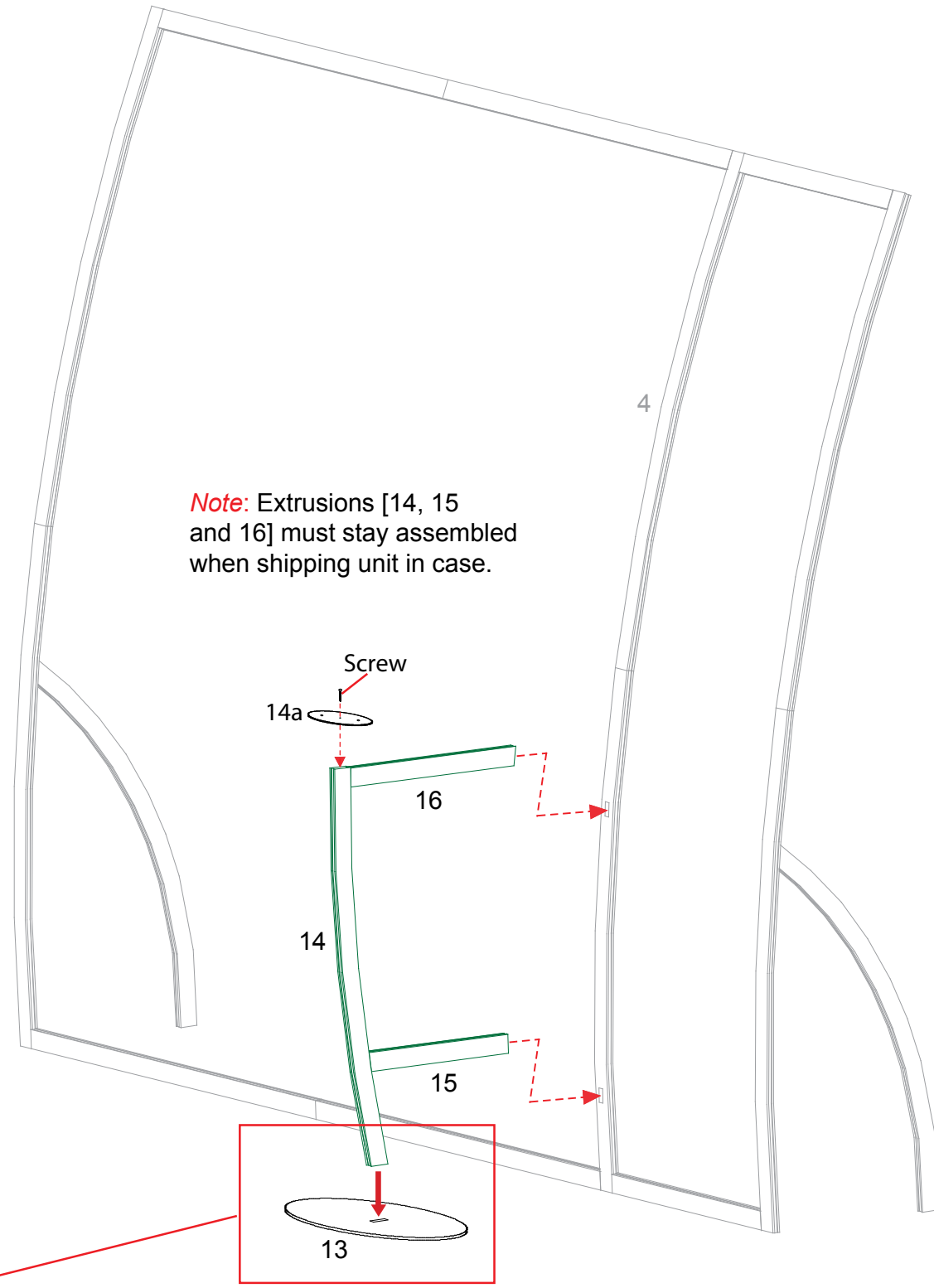

Base Plate Attachment

Connect Vertical Extrusion to Base Plate by placing lock into slot and tighten with tool.

Counter Top Attachment

Insert screws located on underside of counter into holes on flange plate and secure with wing nuts.

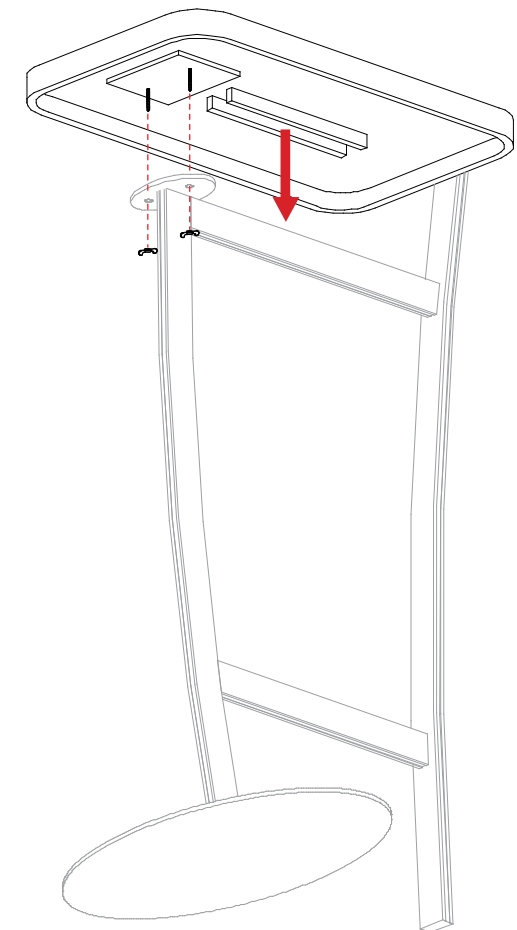

WHEN DISASSEMBLING ALUMINUM EXTRUSION, TIGHTEN ALL SETSCREWS AND LOCKS TO PREVENT LOSS DURING SHIPPING

Top View of Each Level

Backwall Components

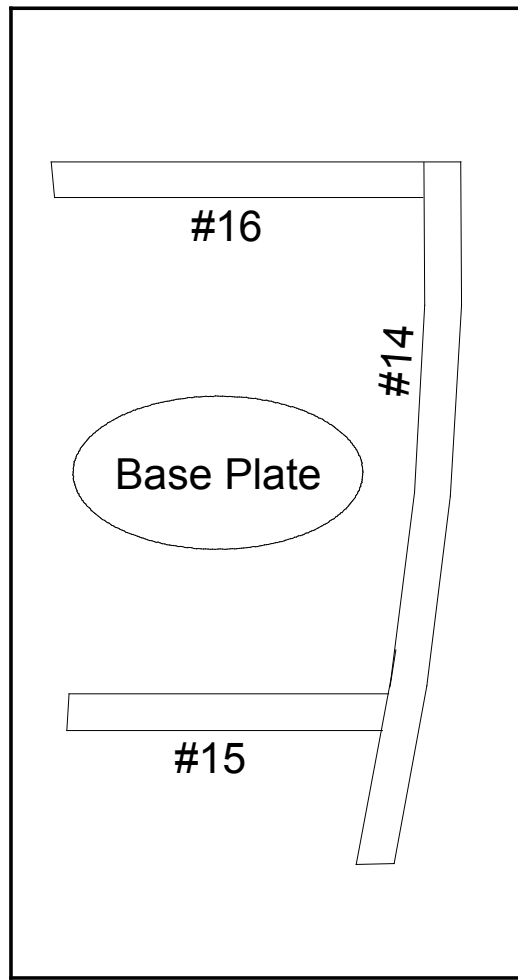

Level 1 (Bottom)

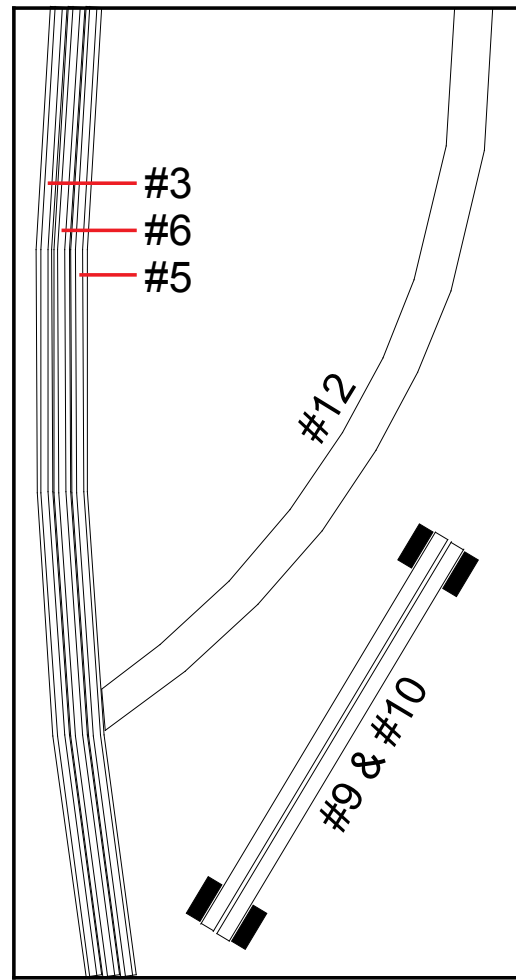

Level 2

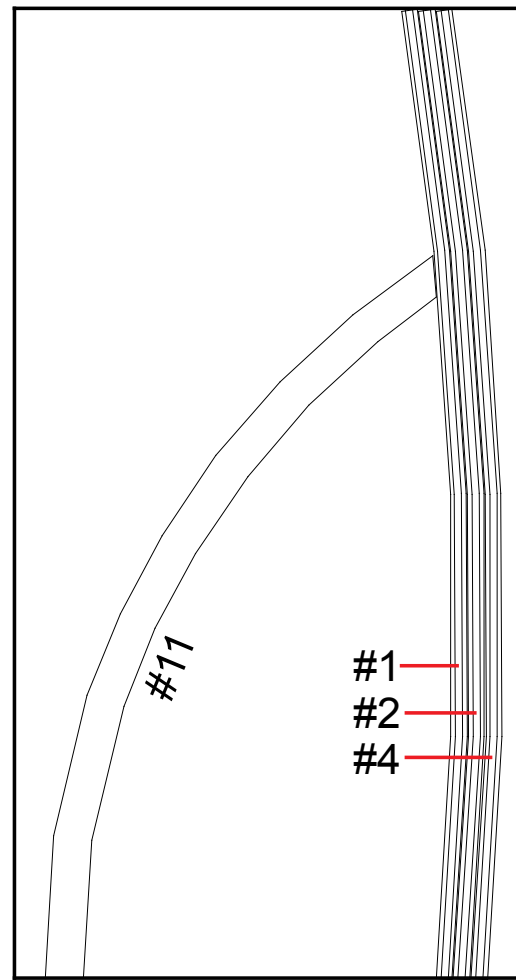

Level 3

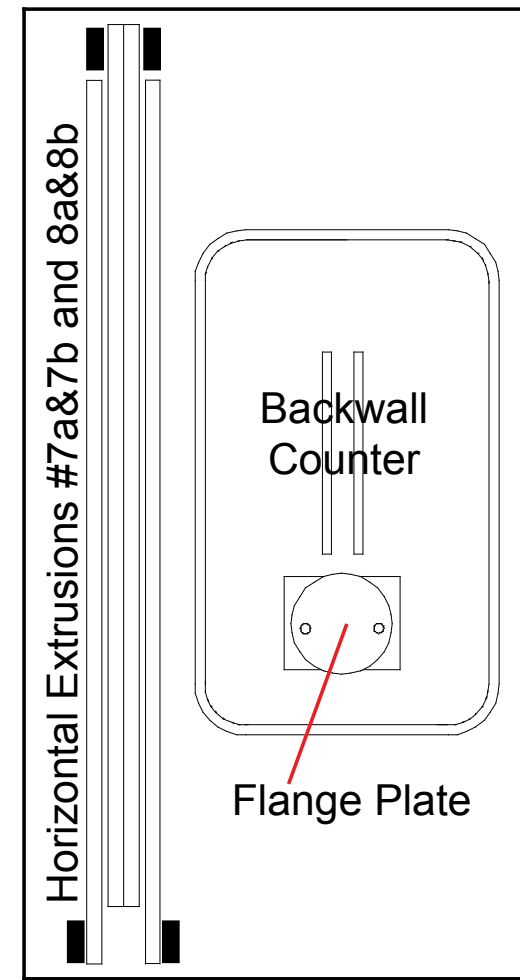

Level 4

Halogen Lights

Graphics

Setup Hardware

WHEN DISASSEMBLING ALUMINUM EXTRUSION, TIGHTEN ALL SETSCREWS AND LOCKS TO PREVENT LOSS DURING SHIPPING